

RF Connectors

SMB Series

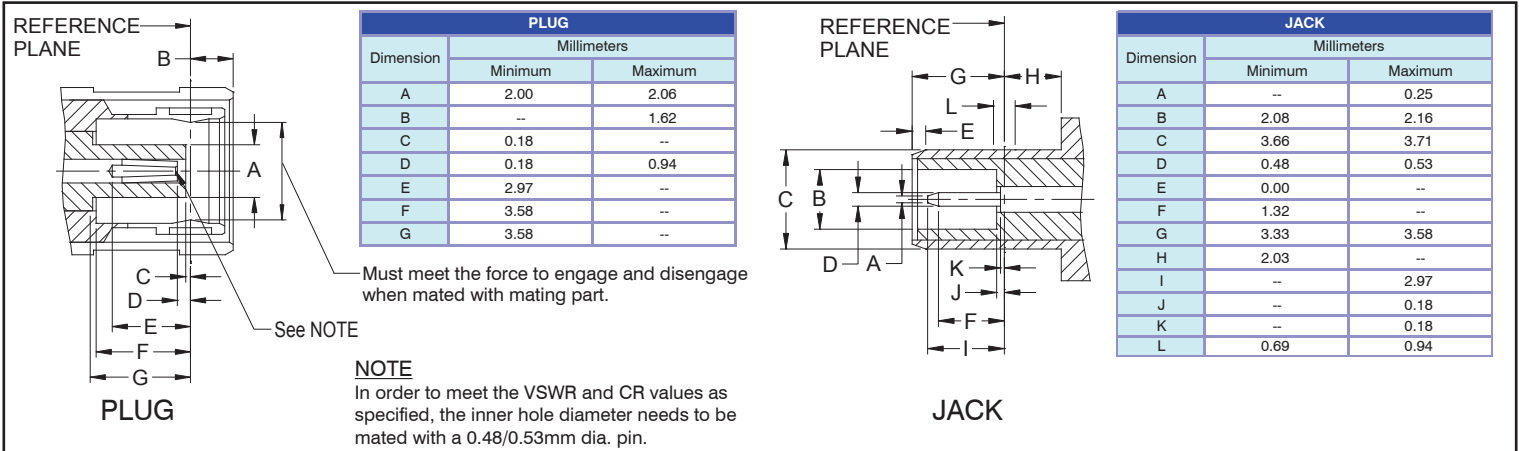

SMB connectors with 50Ω impedance are subminiature devices designed for repeatable electrical performance up to 4 GHz. These SMB connectors offer a simple open/close snap-on coupling feature and which have become very popular in telecommunications, test equipments and instrumentation.



Electrical	
Impedance	50 Ω
Frequency Range	0 - 4 GHz
Working Voltage	RG-178: 250 V rms max. RG-316, .085": 335 V rms max.
Dielectric Withstanding Voltage	RG-178: 500 V rms min. RG-316, .085": 1000 V rms min.
VSWR	Straight: 1.3 max. Right Angle: 1.5 max.
Contact Resistance	Center Contact: 6 mΩ max. Outer Contact: 2.5 mΩ max.
Insulator Resistance	1000 MΩ min.

Material		
Parts Name	Material	Finish
Body, Metal Parts	Brass per QQ-B-626	Gold 0.07μm (3 μ")
Center Contacts	Male: Brass per QQ-B-626	Gold 0.75μm (30 μ")
	Female: Beryllium copper per QQ-C-530	Gold 0.75μm (30 μ")
Insulators	Teflon	None
Crimp Ferrules	Annealed Brass	Gold 0.07μm (3 μ")

NOTE: Other materials and platings are available on request.

Mechanical & Environmental	
Engagement / Disengagement Force	62 N max.
Contact Retention	18 N min.
Durability(Mating)	500 cycles min.
Temperature Range	-65°C to +155°C
Vibration	MIL-STD-202 Method 204 Test Cond. B.
Salt Spray	MIL-STD-202 Method 101 Test Cond. B.
Thermal Shock	MIL-STD-202 Method 107 Test Cond. B.

How to order

RF X - SB X - XX X 5 xx - 58

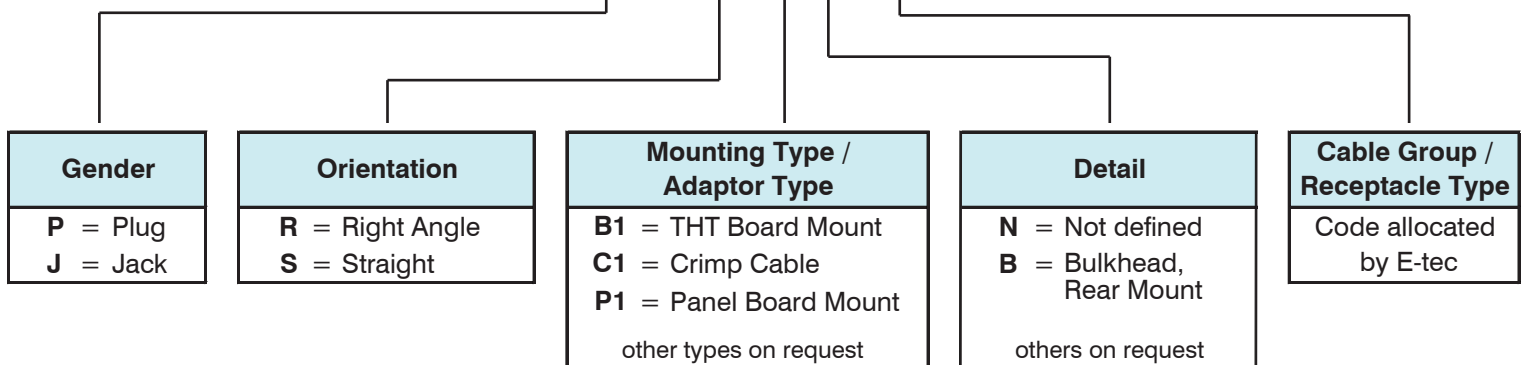

RF Connectors

SMB Series

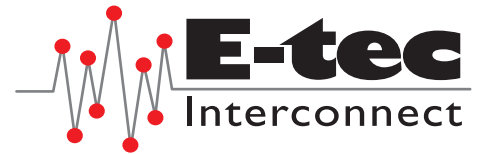

STRAIGHT THT JACK

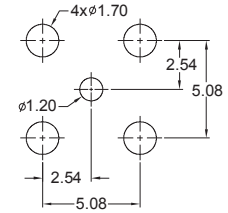
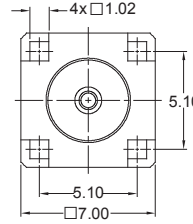
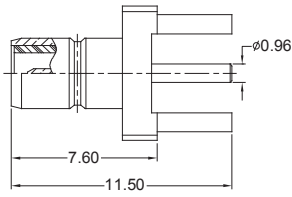
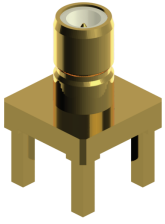

PCB Hole Layout

Order Code
RFJ-SBS-B1N592-58

R/A THT PLUG

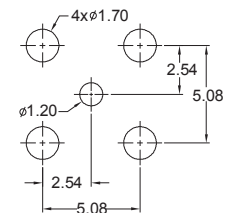
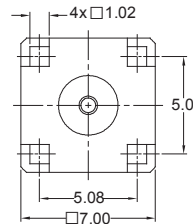
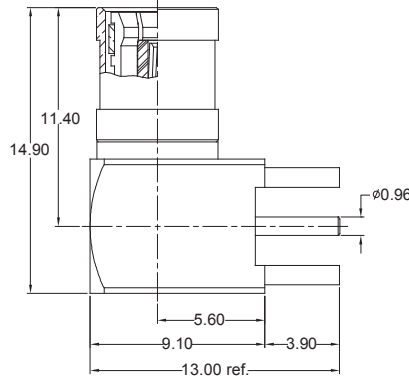
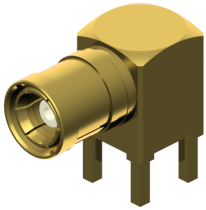

PCB Hole Layout

Order Code
RFP-SBR-B1N592-58

CRIMP JACK

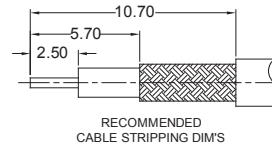
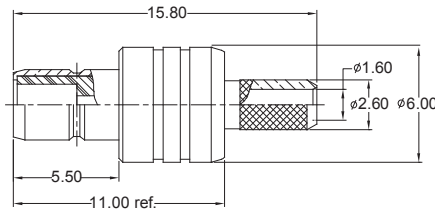
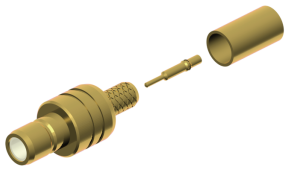

CABLE TYPES
RG-174/U, 188A/U, 316/U, LMR-100

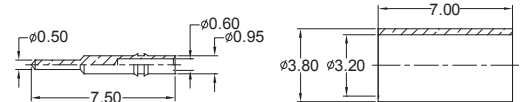

Order Code
RFJ-SBS-C1N502-58

CRIMP PLUG

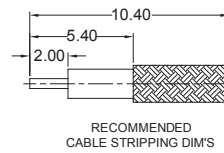
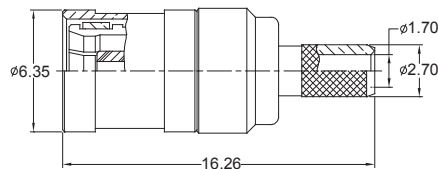
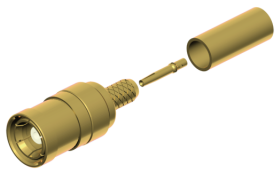

CABLE TYPES
RG-174/U, 188A/U, 316/U, LMR-100

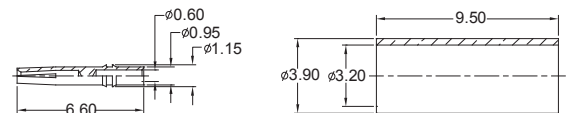

Order Code
RFP-SBS-C1N502-58

PANEL JACK

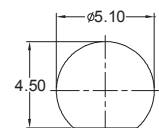
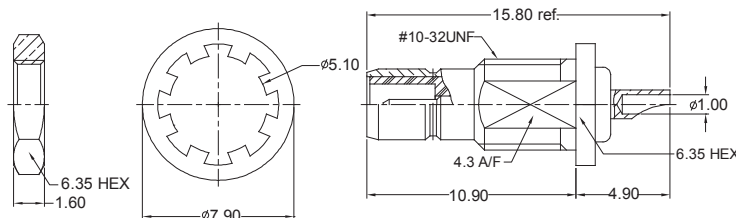

RECOMMENDED MOUNTING HOLE

Order Code
RFJ-SBS-P1B591-58

Other SMB types available on request